

# SAVE VTR 300/B

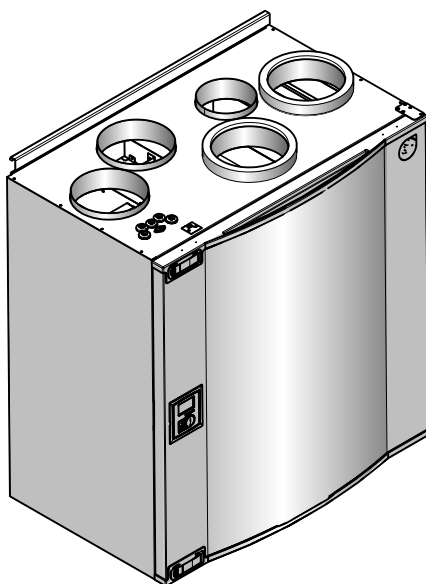

## **GB** Installation and Service

**Systemair is not liable or bound by warranty if these instructions are not adhered to during installation or service.**

© 2016 Copyright Systemair AB

Systemair AB can accept no responsibility for possible errors in catalogues, brochures and other printed material. Systemair AB reserves the right to alter its products without notice. This also applies to products already on order provided that such alterations can be made without sub sequential changes being necessary in specifications already agreed.

All rights reserved.

## Contents

1 Declaration of Conformity .....	1
2 Disposal and recycling .....	2
3 Warnings .....	2
4 About this document .....	2
5 Product information .....	3
5.1 General .....	3
5.2 Left and Right models .....	3
5.3 Transport and storage .....	3
5.4 Technical data .....	4
6 Installation .....	7
6.1 Unpacking .....	7
6.2 Where/how to install .....	7
6.3 Installation procedure .....	7
6.4 Condensation drainage .....	8
7 Commissioning .....	8
7.1 Control panel .....	9
7.2 Start up wizard .....	10
7.3 System curves .....	12
7.4 Airflow settings .....	13
7.5 Defrost level settings .....	15
7.6 Moisture transfer control .....	16
7.7 Programming the Week schedule .....	16
7.8 Ext/Force run .....	17
7.9 Extra functions .....	17
7.10 Electrical connections .....	18
7.11 External connections on the unit .....	20
8 Before starting the system .....	21
9 Operation .....	21
9.1 Setting the temperature .....	21
9.2 Manual setting of airflow .....	21
9.3 Manual and automatic summer mode .....	22
9.4 Cool recovery .....	22
9.5 Service menu overview .....	22
10 Service .....	34
10.1 Warnings .....	34
10.2 Internal components .....	34
10.3 Component descriptions .....	35
10.4 Trouble shooting .....	37
10.5 Alarm list .....	38
10.6 Replacing rotor drive belt .....	40

# 1 Declaration of Conformity

## Manufacturer



Systemair UAB  
Linių st. 101  
LT-20174 Ukmergė, LITHUANIA  
Office: +370 340 60165 Fax: +370 340 60166  
www.systemair.com

## hereby confirms that the following product:

Heat recovery ventilation unit: SAVE VTR 300/B

(The declaration applies only to product in the condition it was delivered in and installed in the facility in accordance with the included installation instructions. The insurance does not cover components that are added or actions carried out subsequently on the product).

## Comply with all applicable requirements in the following directives:

- Machinery Directive 2006/42/EC
- Low Voltage Directive 2014/35/EU
- EMC Directive 2014/30/EU
- Ecodesign Directive 2009/125/EC

## The following regulations are applied in applicable parts:

1253/2014	Requirements for ventilation units
1254/2014	Energy labelling of residential ventilation units
327/2011	Requirements for fans above 125 W

## The following harmonized standards are applied in applicable parts:

EN ISO 12100:2010	Safety of machinery - General principles for design - Risk assessment and risk reduction
EN 13857	Safety of machinery – Safety distances to prevent hazard zones being reached by upper or lower limbs
EN 60 335-1	Household and similar electrical appliances – Safety Part 1: General requirements
EN 60 335-2-40	Safety of household and similar electrical appliances – Part 2-40: Particular requirements for electrical heat pumps, air-conditioners and dehumidifiers
EN 62233	Measurement methods for electromagnetic fields of household appliances and similar apparatus with regard to human exposure
EN 50 106:2007	Safety of household and similar appliances – Particular rules for routine tests referring to appliances under the scope of EN 60 335-1 and EN 60967
EN 61000-6-2	Electromagnetic compatibility (EMC) – Part 6-2: Generic standards – Immunity for industrial environments
EN 61000-6-3	Electromagnetic compatibility (EMC) – Part 6-3: Generic standards – Emission standards for residential, commercial and light-industrial environments

Skinnskatteberg, 30-03-2016



Mats Sándor  
Technical Director

## 2 Disposal and recycling

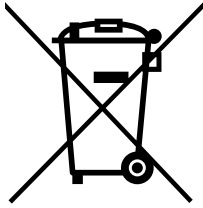

This product are applicable to the WEEE directive. When disposing the unit, follow your local rules and regulations.

This product packing materials are recyclable and can be reused. Do not dispose in household waste.



## 3 Warnings

The following admonitions will be presented in different sections of the document:

### **Danger**

- Make sure that the mains supply to the unit is disconnected before performing any maintenance or electrical work!
- All electrical connections and maintenance work must be carried out by an authorized installer and in accordance with local rules and regulations.

### **Warning**

- The system should operate continuously, and only be stopped for maintenance/service.
- The installation of the unit and complete ventilation system must be performed by an authorized installer and in accordance with local rules and regulations.
- Beware of sharp edges during mounting and maintenance. Use protective gloves.
- All though the Mains supply to the unit has been disconnected there is still risk for injury due to rotating parts that have not come to a complete standstill.
- Make sure that filters are mounted before starting the unit.
- This product must only be operated by a person which has suitable knowledge or education within this field or carried out with the supervision of a suitably qualified person.

### **Caution**

- Do not connect tumble dryers to the ventilation system.
- Duct connections/duct ends must be covered during storage and installation.

## 4 About this document

This installation manual concerns air handling unit type SAVE VTR 300/B manufactured by Systemair AB. The manual consists of basic information and recommendations concerning the design, installation, start-up and operation, to ensure a proper fail-free operation of the unit.

The key to proper and safe operating of the unit is to read this manual thoroughly, use the unit according to given guidelines and adhere to all safety requirements.

## 5 Product information

### 5.1 General

The SAVE VTR 300/B is a heat recovery ventilation unit, with a built in rotating heat exchanger. The SAVE VTR 300/B is suitable for houses with up to 240 m<sup>2</sup> heated living area.

The SAVE VTR 300/B supplies filtered outdoor air to residential areas and extract air from bathroom, kitchen and wet rooms. SAVE VTR 300/B is equipped with a 1670 W electrical re-heater battery.

### 5.2 Left and Right models

There are two model options, right (R) and left (L) model. The different models are recognized by the placing of the internal components and the supply air outlet, which is situated on left side of the unit on an (L) unit and on the right hand side on an (R) unit.

---

**Note:**

This document describes a left (L) model. The inside of a right (R) model is mirrored.

---

### 5.3 Transport and storage

The SAVE VTR 300/B should be stored and transported in such a way that it is protected against physical damage that can harm panels etc. It should be covered so dust, rain and snow cannot enter and damage the unit and its components.

The appliance is delivered in one piece containing all necessary components, wrapped in plastic on a pallet for easy transportation.

## 5.4 Technical data

### 5.4.1 Dimensions and Weight, L model

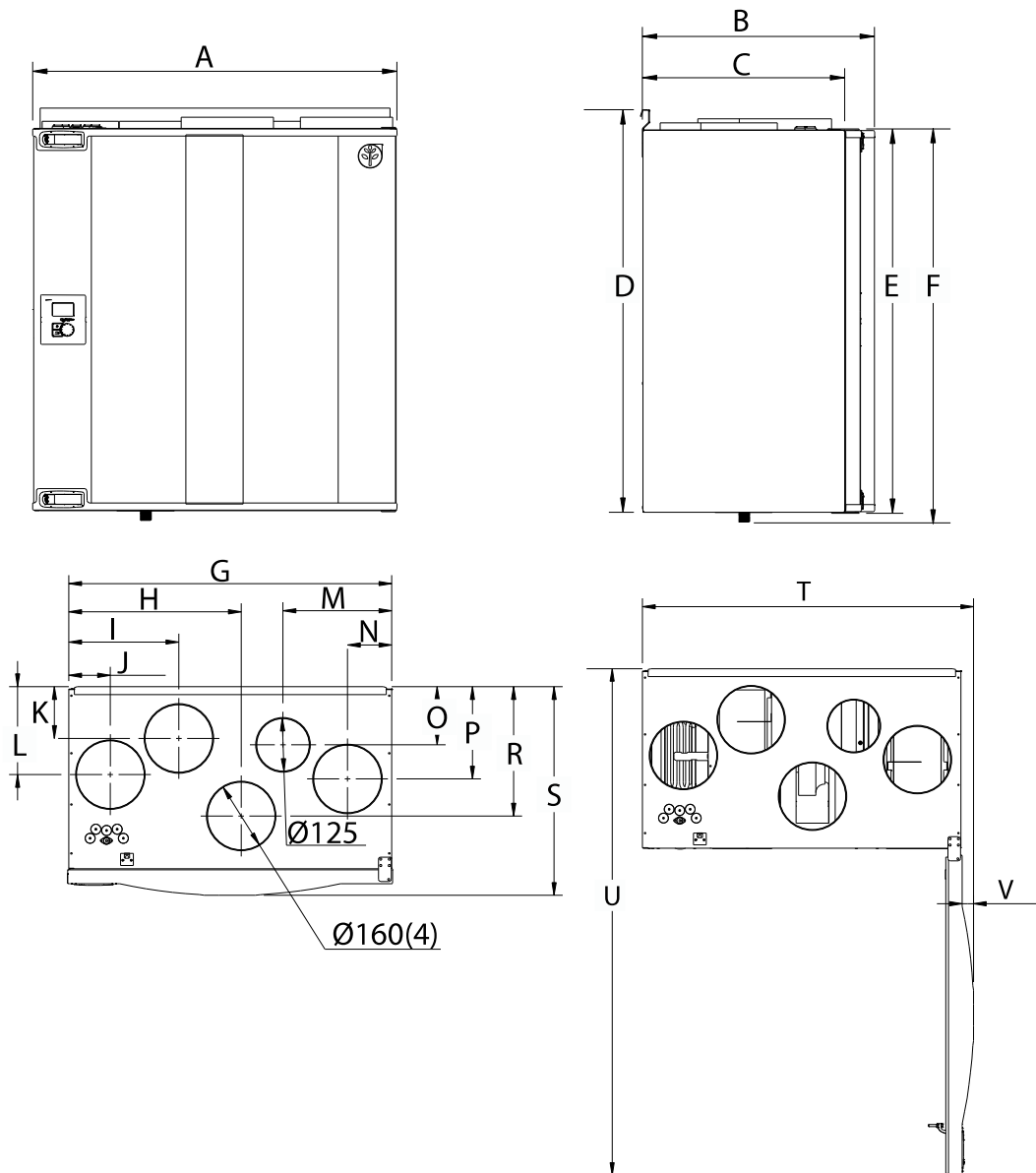

**Fig. 1 Dimensions and weight, L model**

Measures in mm and weight in kg.

A	B	C	D	E	F	G	H	I	J	K
762	485 <sup>1</sup>	423 <sup>2</sup>	842	804	824	758	405	258	97	121
L	M	N	O	P	R	S	T	U	V	Weight
206	255	104	136	216	303	490	788	1206	27	66

1. Including hatch
2. Including bracket

## 5.4.2 Dimensions and Weight, R model

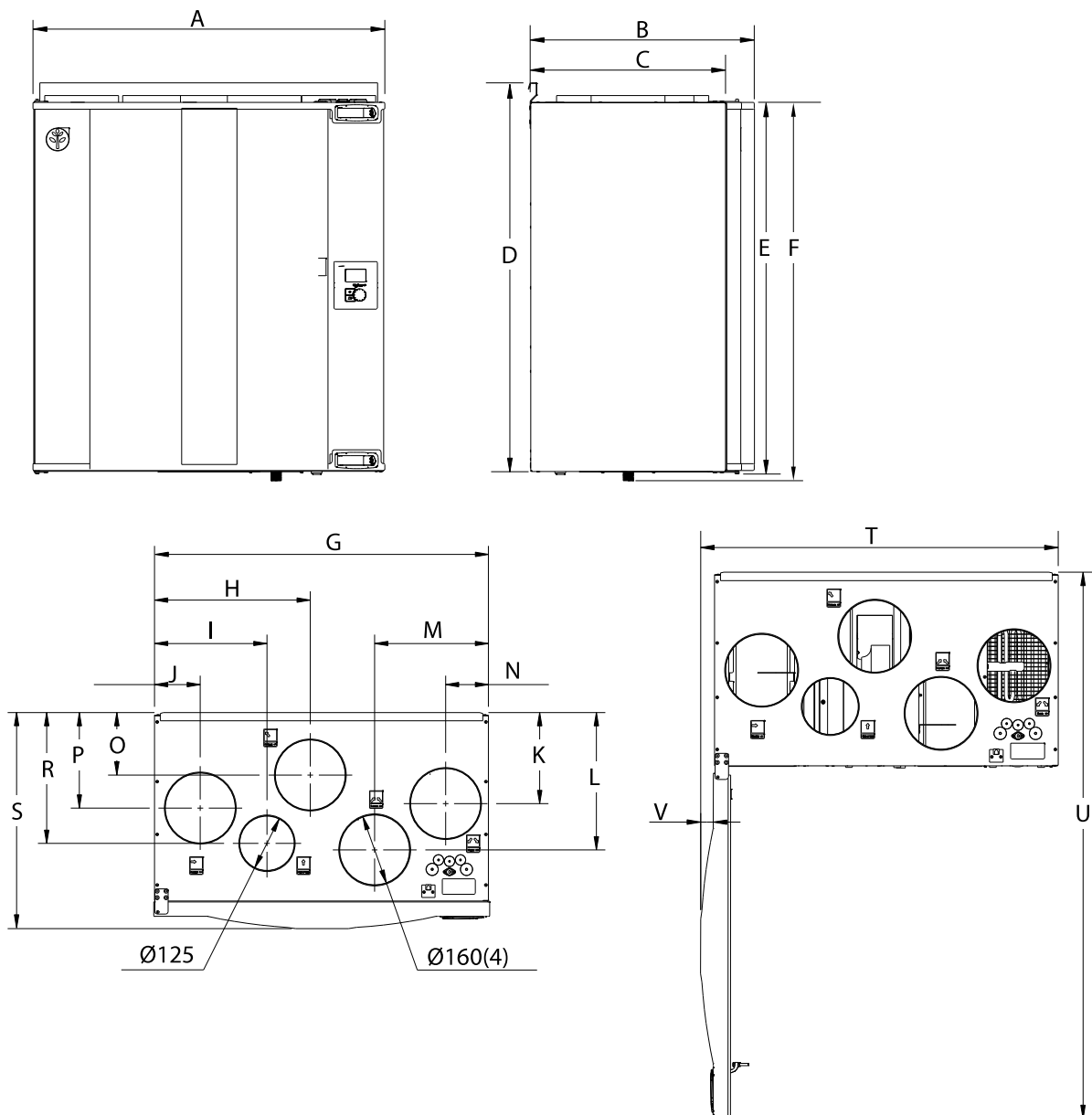

**Fig. 2 Dimensions and weight, R model**

Measures in mm and weight in kg.

A	B	C	D	E	F	G	H	I	J	K	
762	486 <sup>1</sup>	423 <sup>2</sup>	842	804	824	758	354	255	104	206	
L	M	N	O	P	R	S	T	U	V	Weight	
311	258	97	141	216	296	490	789	1206	28	66	

1. Including hatch
2. Including bracket

### 5.4.3 Duct connections

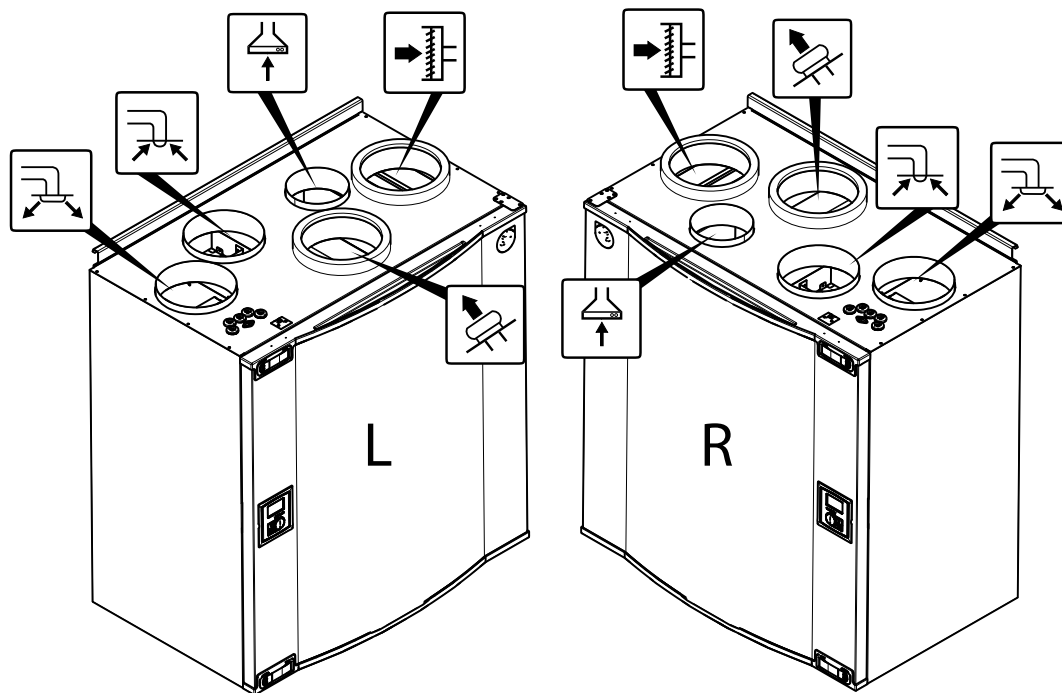

**Fig. 3 Duct connections**

Position	Description
<b>R</b>	Right hand model (Supply air connection is situated on the right hand side of the unit viewed from the front)
<b>L</b>	Left hand model (Supply air connection panel is situated on the left hand side of the unit viewed from the front)

Symbol	Description	Symbol	Description	Symbol	Description
	Supply air		Outdoor air		Cooker hood air
	Exhaust air		Extract air		

### 5.4.4 Power consumption and fuse size

Re-heater	1670 W
Fans	176 W
Total power consumption	1846 W
Fuse	10 A



## 6 Installation

This section describes how to install the unit correctly. To ensure a proper and fail-free operation, it is important that the unit is installed according to these instructions.

### 6.1 Unpacking

Verify that all ordered equipment are delivered before starting the installation. Any discrepancies from the ordered equipment must be reported to the supplier of Systemair products.

### 6.2 Where/how to install

The SAVE VTR 300/B should preferably be installed in a separate room (e.g. storeroom, laundry room or similar.).

When choosing the installation position, consideration must be taken that the unit requires regular maintenance. Leave free space for opening of the front hatch in order to perform service and maintenance on components inside the unit.

The SAVE VTR 300/B is supplied with approximately 1 m cable and plug for 230V, single phase earthed connection placed at the bottom of the unit.

Recommended installation location for the outdoor air intake is the northern or eastern side of the building and with a distance to openings for discharge of stale ventilation air, kitchen ventilator, central vacuum system, waste water drainage and other pollution sources like exhaust from traffic etc. Stale discharge air should ideally be led via a roof unit to the outside and with a good distance to any outdoor air intake, windows etc.

### 6.3 Installation procedure

---

#### Note:

It is recommended to remove the heat exchanger before the installation to make the unit lighter. The heat exchanger weighs about 14 kg. How to remove the heat exchanger, see chapter 6.3.1 steps 1 through 3.

---

1. Prepare the surface where the unit is to be mounted. Make sure that the surface is flat, vertical and that it supports the weight of the unit. Perform the installation in accordance with local rules and regulations.
2. Fit the mounting bracket (1) with the anti-vibration pad (2) to the wall with enclosed screws. Use appropriate holes to screw the bracket firmly to the wall. Bottom side of bracket should be 40 mm (H) below top of unit position.

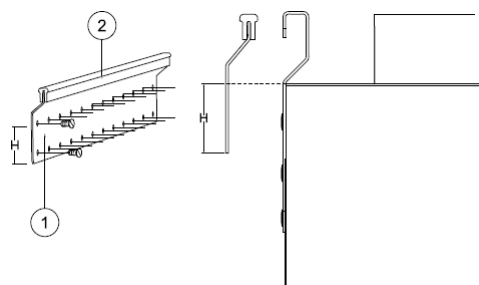



---

#### Note:

Make sure that the mounting bracket is completely horizontal once mounted on the wall. Check with a spirit level.

---

### 3. Lift the unit in place

 <b>Warning</b>
<p>Beware of sharp edges during mounting and maintenance. Use protective gloves.</p> <p>Consider the unit weight when mounting!</p>

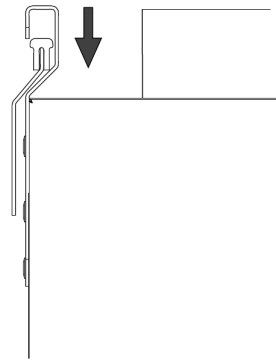

#### Note:

Make sure that the unit is completely vertical and horizontal once mounted on the wall. Check with a spirit level.

### 4. Connect the unit to the duct system. Make sure that all necessary accessories are used to create a functional ventilation solution.

 <b>Warning</b>
<p>The installation of the unit and complete ventilation system must be performed by an authorized installer and in accordance with local rules and regulations.</p>

### 5. Remount the heat exchanger if it was removed before the installation. See chapter 6.3.1 steps 4 and 5.

## 6.3.1 How to remove and remount the heat exchanger

1. Open the front hatch.
2. Disconnect the heat exchanger power supply and the rotor sensor. Both cables are found beside the heat exchanger.
3. Pull out the heat exchanger. Some force may be needed.
4. Remount the heat exchanger. Don't forget to reconnect the heat exchanger power and sensor cables.
5. Close and lock the front hatch.

## 6.4 Condensation drainage

In general no condensation drainage is needed for rotational heat exchangers at dry conditions. However, if a lot of humid air is present in the residence, a condensation drainage might be needed. Drainage connection is available as an accessory and can be ordered separately. Installation instructions for the drainage are enclosed in the drainage pipes delivery.

#### Note:

The drainage connection is plugged in the bottom of the unit at delivery. To use the drainage: remove the rubber seal and connect the drainage pipe. Connect the drainage pipe to the sewer. The water can not be led straight to the sewer without a water trap.

## 7 Commissioning

Connect the unit electrically to the mains with the enclosed plug.

## 7.1 Control panel

Connect the unit electrically to the mains with the enclosed plug and check that it starts up correctly.

The control panel is used to make the necessary adjustments.

An external control panel can be connected on the top of the unit.



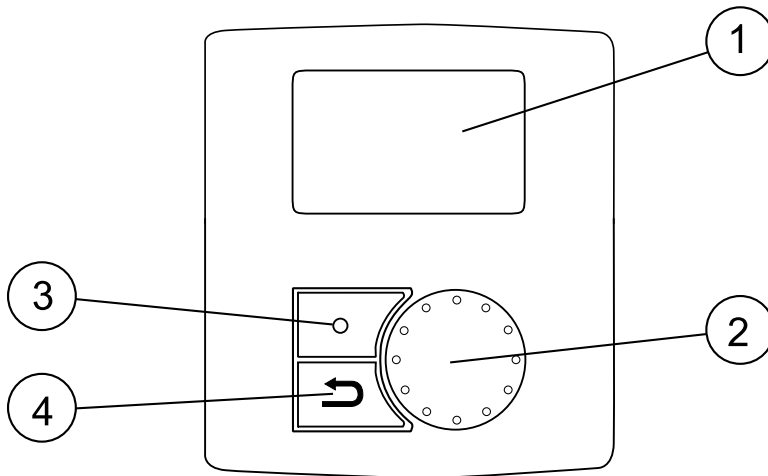



The illustration below shows the control panel with a short description.

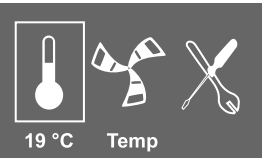
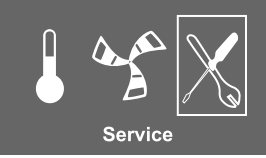
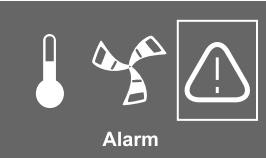

**Fig. 4 Control panel**

Position	Description	Explanation
1	Display	Shows symbols, menus and settings
2	SELECTION knob	Move through the menu lists or change settings and values by turning the knob left or right
3	ENTER button	ENTER menu choices or settings by pressing the button
4	RETURN button	Step RETURN in the menu levels and to abort an initiated parameter change and restore the original value by pressing the button

### 7.1.1 Display symbols

Symbol	Description	Explanation
	Temp	<p>Illustrates the current set-point for supply air temperature (from completely empty to filled symbol).</p> <p>Turn the SELECTION knob to choose temperature.</p> <p>Press ENTER to save the setting.</p>
	Airflow	<p>Illustrates the current airflow. The airflow can be set manually in 5 steps: Off, Low, Nom, High and Auto.</p> <p>Turn the SELECTION knob to choose airflow.</p> <p>Press ENTER to save the setting.</p> <div style="display: flex; justify-content: space-around; align-items: center;">      </div> <p>A. Ventilation off.<sup>1</sup></p>

Symbol	Description	Explanation
		<p>B. Low ventilation: Can be used when leaving the building for a longer period</p> <p>C. Nominal ventilation: Will give required air change under normal conditions.</p> <p>D. Maximum ventilation: To increase the airflow if necessary.</p> <p>E. Auto ventilation: Will regulate after the pre-setting for the demand control settings.</p>
 <p>Service</p>	Service	Press ENTER to access the service menu.
 <p>Alarm</p>	Alarm	Press ENTER to access the alarm list.

1. The fan can be set to OFF by activating manual fan stop. See service menu description under functions.



### Important

It is not recommended to activate manual fan stop (set fan to OFF) in standard households. If manual fan stop is activated, the unit should be provided with dampers in exhaust and fresh air ducts to avoid cold draught and risk of condensation when the unit has been stopped.

## 7.2 Start up wizard

The **Start up Wizard** is a step-by-step configuration tool that starts automatically when the SAVE VTR 300/B is started for the first time or when:

- a factory reset is performed
- a new print card is installed (spare part)  
In this case the unit type must be entered ( SAVE VTR 300/B )

The airflow in the Start up wizard can be set by either l/s, m<sup>3</sup>/h or a percentage with the Fan control.

- If *Airflow System curve* is chosen, the settings will be in l/s, m<sup>3</sup>/h and system curves are selected.
- If *Airflow %* is chosen, the settings will be in percentage. System curves are not selectable.

### 7.2.1 Procedure

1. Turn the SELECTION knob to choose language and press ENTER	Languages Language ENGLISH
2. Choose unit type, this choice is only present if a new print card is installed (spare part) or when a factory reset is performed.	Type SAVE VTR 300/B
3. Set date and time	<p><b>Time/Date</b> YY/MM/DD</p> <p>Date: 12/09/12</p> <p>Time: 10:00</p> <p>Weekday: Sat</p>

<p>4. Select heater: None/Electrical/Water/Other</p> <hr/> <p><b>Note:</b></p> <p>This choice is available only after a factory reset, see chapter 7.2.2, or when a new print card is installed.</p> <p>Pre-heater is only available for VTC200.</p>	<p><b>Heater</b></p> <p>Pre-heater: YES/NO Reheater: None/Electrical/Water/Other</p>												
<p>5. Fan control.</p> <p>Turn the SELECTION knob to select the type of fan control you prefer, System curve (l/s) or percentage (%) and press ENTER.</p> <p>Commission by %, see step 7.</p> <hr/> <p><b>Note:</b></p> <p>System curves are not selectable when (%) is chosen.</p> <hr/> <p><b>Note:</b></p> <p>Before setting the system curve, see chapter 7.3 for details.</p> <hr/> <p>This function is implemented in the unit to compensate the flow values for different system pressures.</p> <p>Supply Fan (SF): Total value range: 1–20. For G3 type filter: 11–20, For F7 type filter: 1–10. Default curve: 2</p> <p>Extract Fan (EF): Value range: 1–10 Default curve: 2</p> <hr/> <p><b>Note:</b></p> <p>The factory installed filters are of filter quality F7 for the supply air and G3 for the extract air filter. Air filters are accessories and can be obtained from the installer or wholesaler.</p> <p>The filter type is labelled on the top of the filter.</p>	<p><b>Fan control, Airflow</b></p> <p><b>System curve</b></p> <p>EF: 1–10 SF: 1–20</p>												
<p>6. Here it is possible to change the Nominal/High/Low airflow on the Extract air fan (EF) and Supply air fan (SF). Airflow in l/s.</p> <p>When settings are done, press ENTER.</p>	<table border="1"> <thead> <tr> <th>Airflow l/s</th> <th>EF</th> <th>SF</th> </tr> </thead> <tbody> <tr> <td>Nom</td> <td>82</td> <td>82</td> </tr> <tr> <td>High</td> <td>100</td> <td>100</td> </tr> <tr> <td>Low</td> <td>49</td> <td>49</td> </tr> </tbody> </table>	Airflow l/s	EF	SF	Nom	82	82	High	100	100	Low	49	49
Airflow l/s	EF	SF											
Nom	82	82											
High	100	100											
Low	49	49											
<p>7. Here it is possible to change the Nominal/High/Low airflow on the Extract air fan (EF) and Supply air fan (SF). Airflow in %. System curves not selectable.</p> <p>When settings are done, press ENTER.</p>	<table border="1"> <thead> <tr> <th>Airflow %</th> <th>EF</th> <th>SF</th> </tr> </thead> <tbody> <tr> <td>Nom</td> <td>50</td> <td>50</td> </tr> <tr> <td>High</td> <td>100</td> <td>100</td> </tr> <tr> <td>Low</td> <td>25</td> <td>25</td> </tr> </tbody> </table>	Airflow %	EF	SF	Nom	50	50	High	100	100	Low	25	25
Airflow %	EF	SF											
Nom	50	50											
High	100	100											
Low	25	25											

## 7.2.2 Perform Factory reset

How to perform a factory reset if necessary:

<p>1. Enter the service menu by selecting the service symbol in the display and press ENTER.</p>	
<p>2. Go to password and enter the password, default 1111  Use the SELECTION knob for each digit and confirm with the ENTER button after each set digit and choose NO for the system not be locked.</p>	<p><b>Password</b> Password XXXX Locked YES/NO</p>
<p>3. Go to Functions and select Factory Reset</p>	<p><b>Functions</b> Factory reset</p>
<p>4. Turn the SELECTION knob so YES is shown and press ENTER.</p>	<p><b>Factory reset</b>  Really reset? YES/NO</p>
<p>5. ACCEPTED is shown in the display window</p>	<p><b>ACCEPTED</b></p>
<p>6. The Start up Wizard starts after approximately 10 seconds</p>	

## 7.3 System curves

A system requires different pressures at different airflows, which can be represented by a system curve. The intersection between the system line and the fan curve, is the unit's working point. It is showing the airflow the system is going to have. Every change in the pressure of the ventilation system, will give rise to a new system curve.

If you choose to do the commissioning with l/s or m<sup>3</sup>/h, you need to know the system's pressure in order to choose a suitable system curve.

### 7.3.1 Supply air, F7 type filter

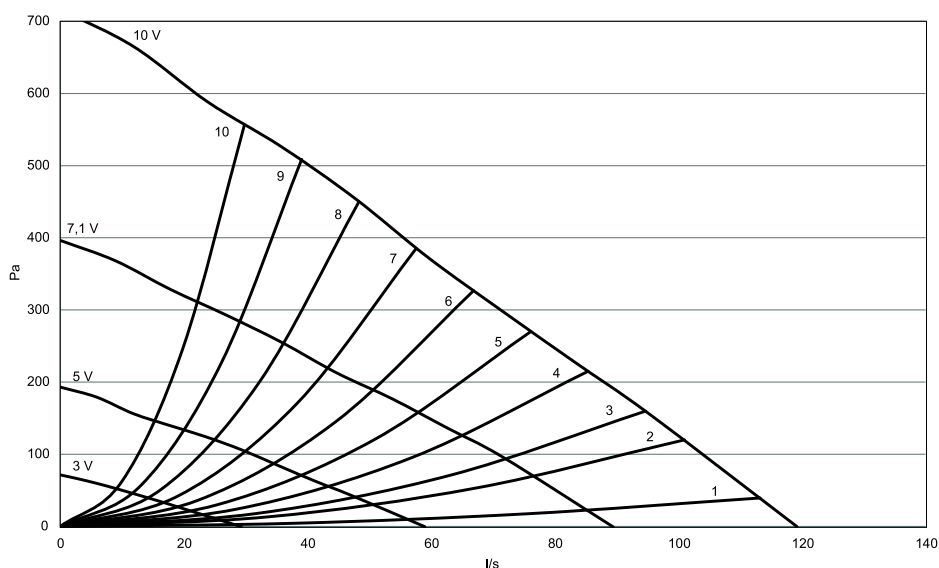

**Fig. 5 Supply air system curves, F7 type filter**

### 7.3.2 Supply air, G3 type filter

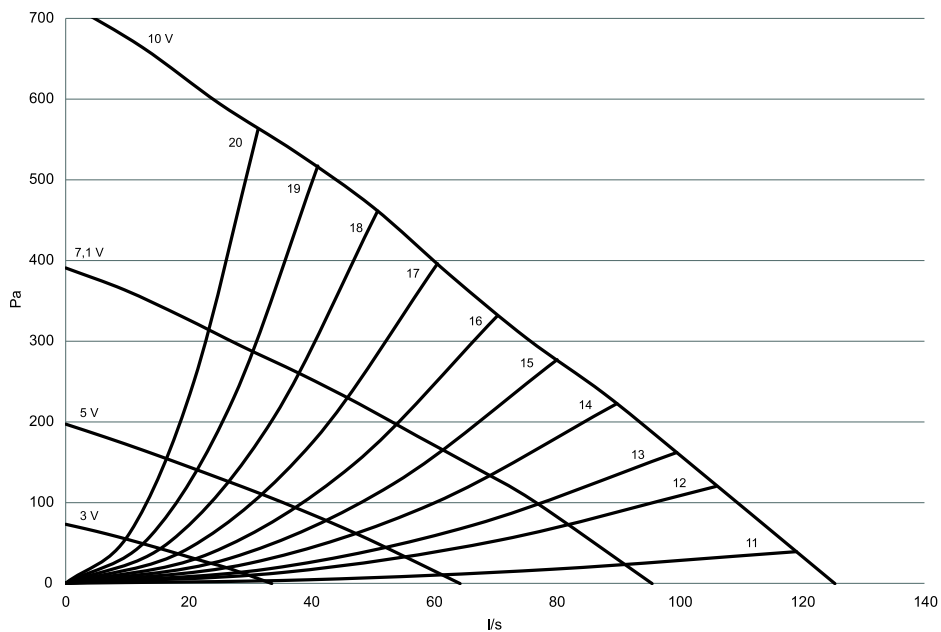

Fig. 6 Supply air system curves, G3 type filter

### 7.3.3 Extract air, G3 type filter

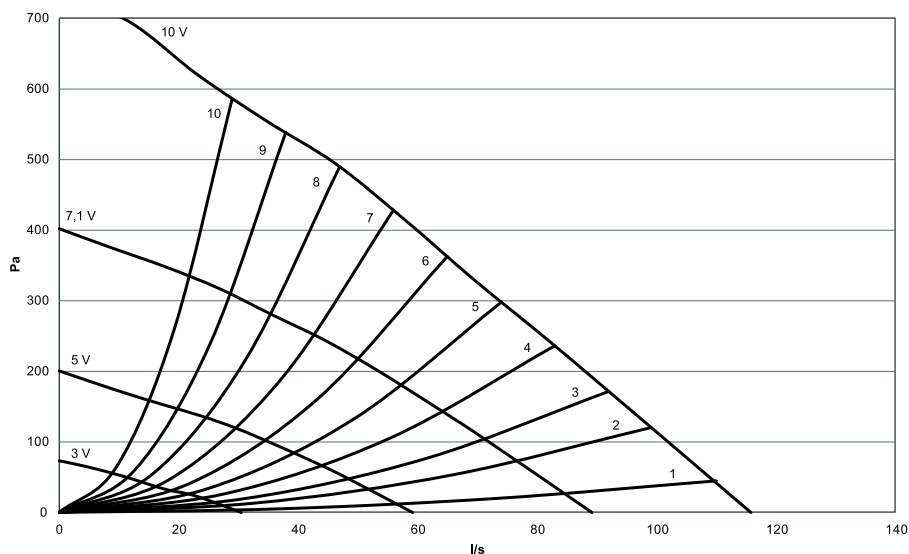

Fig. 7 Extract air system curves, G3 type filter

## 7.4 Airflow settings

The airflow can be set by either l/s, m<sup>3</sup>/h or a percentage.

- If `Airflow System curve` is chosen, the settings will be in l/s, m<sup>3</sup>/h and system curves are selected.
- If `Airflow %` is chosen, the settings will be in percentage. System curves are not selectable.

The airflow may be adjusted in five steps; off, low, nominal, high and auto. These settings control the output signals to the supply- and extract fans. The factory setting on each speed steps are:

- Off

- Low: 49 l/s or 25 %.
- Nom: 82 l/s or 50 % (at approximately 80 Pa).
- High: 100 l/s or 100 %.
- Auto: In Auto mode the fans regulates in accordance with the pre-settings for the demand control.

These levels are possible to change in the service level. See service menu overview (chapter 9.5) under functions.

### **Warning**

It is **not** recommended to activate manual fan stop (set fan to OFF) in standard households. If manual fan stop is activated, the unit should be provided with dampers in exhaust and fresh air ducts to avoid cold draught and risk of condensation when the unit has been stopped.

The fan can be set to OFF by activating manual fan stop. See service menu overview (chapter 9.5) under functions.

## 7.4.1 Setting the airflow

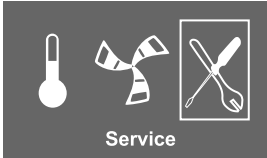
<p>1. Go to the service menu by using the SELECTION knob</p>	 <p style="text-align: center;">Service</p>															
<p>2. Enter the service level by typing the password, default 1111. Use the SELECTION knob for each digit and confirm with the ENTER button after each set digit and choose "NO" for the system not be locked.</p>	<p><b>Password</b> Password XXXX Locked YES/NO</p>															
<p>3. Go to: Functions Choose: Fan control</p>	<p><b>Functions</b> -&gt; Fan control</p>															
<p>4. Turn the SELECTION knob to select the type of fan control you prefer, System curve (l/s) or percentage (%) and press ENTER. Fan control by Airflow %, see step 7.</p>	<p><b>Fan control</b> System curve %</p>															
<p>5. Fan control by Airflow l/s. When settings are done, press ENTER.  Choose System curve.</p>	<p><b>Fan control</b> Airflow System curve  SF: 2      EF: 2</p>															
<p>6. Press RETURN once the system curves has been set and go to Airflow l/s or m<sup>3</sup>/h. When settings are done, press ENTER.</p>	<table border="1"> <thead> <tr> <th>Airflow</th> <th>EF</th> <th>SF</th> </tr> </thead> <tbody> <tr> <td><b>l/s</b></td> <td></td> <td></td> </tr> <tr> <td>Nom</td> <td>82</td> <td>82</td> </tr> <tr> <td>High</td> <td>100</td> <td>100</td> </tr> <tr> <td>Low</td> <td>49</td> <td>49</td> </tr> </tbody> </table>	Airflow	EF	SF	<b>l/s</b>			Nom	82	82	High	100	100	Low	49	49
Airflow	EF	SF														
<b>l/s</b>																
Nom	82	82														
High	100	100														
Low	49	49														
<p>7. Fan control by Airflow % When settings are done, press ENTER.</p>	<table border="1"> <thead> <tr> <th>Airflow</th> <th>EF</th> <th>SF</th> </tr> </thead> <tbody> <tr> <td><b>%</b></td> <td></td> <td></td> </tr> <tr> <td>Nom</td> <td>50</td> <td>50</td> </tr> <tr> <td>High</td> <td>100</td> <td>100</td> </tr> <tr> <td>Low</td> <td>25</td> <td>25</td> </tr> </tbody> </table>	Airflow	EF	SF	<b>%</b>			Nom	50	50	High	100	100	Low	25	25
Airflow	EF	SF														
<b>%</b>																
Nom	50	50														
High	100	100														
Low	25	25														



## 7.5 Defrost level settings

Defrost level settings are active and adjustable if `Exchanger Control` setting in service menu is set to `On/Off`.

The unit is equipped with an automatic defrost function that is activated when there is risk of icing in the area around the heat exchanger. The setting shown in table 1 determines how aggressive the defrosting will be. Default factory defrost mode setting is 0.

### Note:

The heat exchanger should withstand low outdoor temperatures, but in those cases where icing can occur please be aware of that the defrost setting will generate an under pressure in the building. Using a fire place, be aware that there is a possible risk of smoke being extracted into the living areas due to under pressure if defrosting is activated.

**Table 1: Defrost levels**

Defrost level	Level of humidity	Relative humidity indoors <sup>1</sup>	Description
0		<20%	Defrosting is turned off. Areas where relative humidity is very low.  <b>Note:</b> This setting is not valid for units equipped with counter flow heat exchangers when RH sensor is set not to be used for defrosting.
1	Min	20% - 29%	Dry areas, such as warehouse buildings with few people or industrial buildings that don't use water in their production process.
2	Low	30% - 40%	Office buildings
3	Medium	41% - 60%	Apartments or houses with normal humidity <sup>2</sup>
4	High	61% - 80%	Apartments or houses with high humidity
5	Extremely high	>80%	Buildings with very high humidity level.

1. *Approximate values of relative humidity in the extract air at cold outdoor temperatures.*
2. *In newly constructed houses it might be necessary with a higher defrost level during the first winter period.*

### 7.5.1 Setting the defrost level

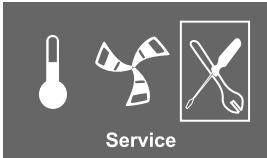
1. Go to the service menu by using the SELECTION knob.	
2. Enter the service level by typing the password, default 1111. Use the SELECTION knob for each digit and confirm with the ENTER button after each set digit and choose "NO" for the system not be locked.	<b>Password</b> Password XXXX Locked YES/NO
3. Go to: Functions Choose: Defrosting	<b>Functions</b> Defrosting

4. Set the mode	<b>Defrosting</b> Mode 0-5
<b>Note:</b> This setting is only valid for units equipped with counter flow heat exchangers.	Allow unbalance YES/NO
5. Select if unbalanced airflows are allowed in the building during the defrost cycle. Choose between YES and NO. Default is YES.	

## 7.6 Moisture transfer control

Moisture transfer control is activated and adjusted if `Exchanger Control` setting in service menu is set to `Variable`.

A rotating heat exchanger with variable rotor drive is controlled to decrease moisture transfer over to supply air in buildings with high or periodically high relative humidity. This function has also indirect impact as defrosting function for the rotor.

If the moisture transfer control is enabled, the lowest regulating signal from temperature and humidity sensors is controlling the rotor drive.

## 7.7 Programming the Week schedule

Set the week schedule according to below procedure:

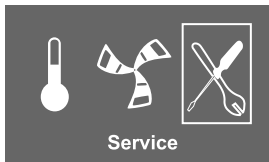
1. Go to the service menu by using the SELECTION knob.	
2. Enter the service level by typing the password, default 1111. Use the SELECTION knob for each digit and confirm with the ENTER button after each set digit and choose "NO" for the system not be locked.	<b>Password</b> Password XXXX Locked YES/NO
3. Go to: <code>Week program</code>	<b>Service</b> <code>Week program</code>
4. Choose <code>Week program</code> again.	<b>Week program</b> <code>Airflow</code>
5. Set week day and time you want the unit to be in ON level. Two periods per day can be programmed. The rest of the time the unit will be in OFF level.	<b>Week program</b> Day: MON Per 1: 07:00 16:00 Per 2: 00:00 00:00
6. Go back to the previous dialogue frame with the RETURN button and go down to <code>Airflow</code> .	<b>Week program</b> <code>Airflow</code>

<p>7. Set which airflow the fan is supposed to be running in the ON level, choose between Low, Nom, High or Auto.</p> <p>Set which airflow the fan is supposed to be running in the OFF level, choose between OFF, Low, Nom or High.</p> <hr/> <p><b>Note:</b></p> <p>If an electrical re-heater battery is installed and active and the unit is shut down from the control panel, for example by choosing OFF. When the unit is in OFF level in the week program, the fans will continue to run for 3 minutes, to prevent the heater from triggering the over heat protection sensor, before they stop.</p>	<p><b>Airflow</b></p> <p>On level: low/nom/high/auto Off level: off/low/nom/high</p>
<p>8. Step back with the RETURN button until you reach the main menu display</p>	

## 7.8 Ext/Force run

It is possible to program extended time you want the unit to work under operation conditions other than determined by the week schedule.

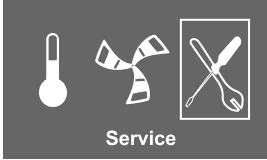
<p>1. Go to the service menu by using the SELECTION knob.</p>	
<p>2. Enter the service level by typing the password, default 1111. Use the SELECTION knob for each digit and confirm with the ENTER button after each set digit and choose "NO" for the system not be locked.</p>	<p><b>Password</b> Password XXXX Locked YES/NO</p>
<p>3. Go to: Ext/Force Run</p>	<p><b>Service</b> Ext/Force Run</p>
<p>4. Set the time in minutes the unit is to run in extended/forced running mode. Value range: 0–240 minutes, in steps of 10 min.</p> <p>Set the airflow for this mode. Choose between Low, Nom or High. Default value: Nom.</p>	<p><b>Ext/Force Run</b></p> <p>Minutes: 0</p> <p>Airflow: Nominal</p>

## 7.9 Extra functions

The unit is equipped with a number of extra on/off functions which can be activated from external on/off switches that can be connected to the digital inputs on the main print card (see wiring diagram).

The following possibilities are available:

- **Digital inputs 1–3:** Are free to be used for any purpose, they also have a different priority, DI 1 being the highest and DI 3 the lowest. DI 1–3 have a higher priority than DI 5. By connecting on/off switches to these inputs it's possible to choose 4 (Off/Low/Normal/High) individual airflow settings in the control panel depending on a temporary need for the building (for example lowering the extract air airflow when an open fire place is used). See chapter 9.5.

DI 3 is prepared and already connected internally for easy access on the unit. See chapter 7.11.

In units with a built-in bypass for cooker hood connection, DI 3 can be used to control external cooker hood. It has to be configured as SF=High and EF=High.

- **Digital input 4:** Makes it possible to disable the electrical/other re-heater

Activated input means that the electrical/other re-heater is disabled.

- **Digital input 5:** Activate the Extended/forced running function with a impulse switch. The function overrides current airflow settings and runs in forced mode according to the settings in *Service -> Ext/Force run*. Choose between Low, Nom and High for this function.

The input is calculated based on the signals from an impulse-switch. If a standard switch is used, the countdown of the set time starts when the switch is switched off.

- **Digital input 6:** Control for the exchanger, used by the system
- **Digital input 7:** Home/leave, switching on this activates low energy support control. The heat exchanger is always operating according to the setpoint value. Is there a re-heater activated it will operate according to the lowest setpoint value (12 °C). The function is used when the building is uninhabited for a longer period.

It is recommended to connect either of DI1, DI2 or DI3 in parallel with DI7. If DI7 is activated, set the fans speed to min. Airflow settings are done when configuring DI1, DI2 or DI3.

See menu options in “Service menu Overview” (chapter 9.5).

## 7.10 Electrical connections

The SAVE VTR 300/B is wired internally from factory.

The electrical connection box can be found on the supply air outlet side of the unit behind a cover plate.

The print card (1) can easily be taken out from the unit.

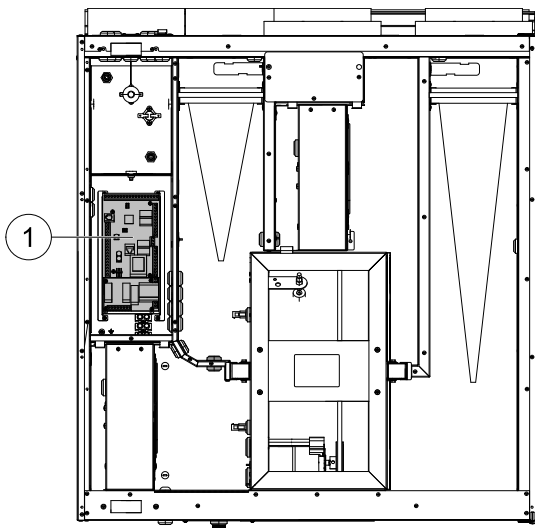
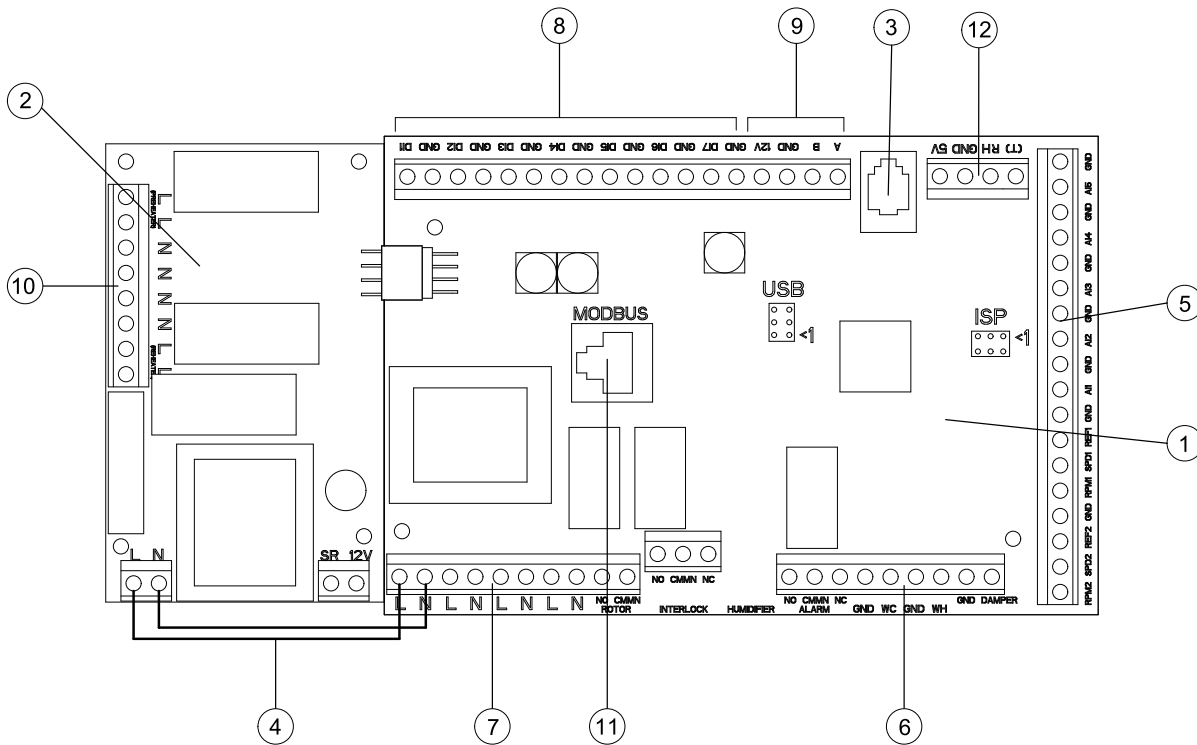

**Fig. 8 Print card position**

### 7.10.1 Print card layout

The SAVE VTR 300/B is equipped with built-in regulation and internal wiring.

The figure shows the print card. See wiring diagram for more information.

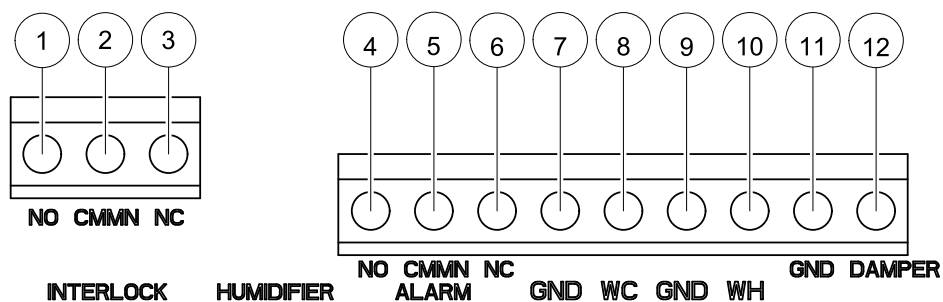

**Fig. 9 Print card**

Position	Description
1	Main print card
2	Print card for electrical heater
3	Connection to external control panel (connected to unit casing)
4	Mains supply connection between main print card and electrical heater print card
5	Terminals for AI 1–5 (temp sensors) and motor control
6	Terminals for external connections
7	Terminals for mains supply connections
8	Terminals for digital inputs (DI 1–7)
9	Terminals for internal control panel.
10	Terminals for regulated power supply to electrical heater
11	Modbus connection. See "User manual Modbus" for details.
12	Terminals for internal relative humidity sensor

## 7.10.2 External connections on the print card

Connection terminals for external equipment can be found on the main print card inside the electrical connection box.



**Fig. 10 External connections on the print card**

Position	Description	Remark
1	Outdoor/exhaust air damper	Normally open, 230 V 1~, max 0,1 A / 24 VAC 1 A
2	Outdoor/exhaust air damper	Reference
3	Outdoor/exhaust air damper	Normally closed, 230 V 1~, max 0,1 A / 24 VAC 1 A
4	Sum alarm	Normally open, 24 V, max 1 A
5	Sum alarm	Reference
6	Sum alarm	Normally closed, 24 V, max 1 A
7	GND	Reference
8	Water cooler control signal (AO2)	0–10 V DC
9	GND	Reference
10	Water heater control signal (AO1)	0–10 V DC
11	GND	Reference
12	Bypass damper/Rotor control (AO3)	If used, 0–10 V DC

## 7.11 External connections on the unit

Two of the connections on the main print card are wired to plugs on the unit casing:

- connection to an external control panel through a modular connector.  
Maximum cable length: 50 m.  
Cable type: Flat 4-conductor CEC Phone cable.
- External Modbus connector.  
Maximum cable length: 90m in cable duct + 10 m in working area.  
Cable type: LAN TCP Cat5E 4x2XAWG24 cable.
- connection to DI 3 with possibility to configure the fan speeds individually through a potential free on/off switch

Default settings: SF=High, EF=Low.

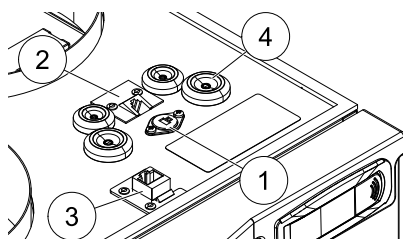

1. Connection to DI 3 through an on/off switch
2. Connection to control panel
3. External Modbus connection
4. Cable glands

## 8 Before starting the system

When the installation is finished, check that:

- The unit is installed in accordance with the instructions
- The unit is correctly wired
- Outdoor and exhaust air dampers and silencers are installed and that the duct system is correctly connected to the unit
- All ducts are sufficiently insulated and installed according to local rules and regulations
- Outdoor air intake is positioned with sufficient distance to pollution sources (kitchen ventilator exhaust, central vacuum system exhaust or similar)
- All external equipment are connected
- The unit is correctly configured and commissioned
- The week schedule and airflow settings are correctly programmed.

## 9 Operation

### 9.1 Setting the temperature

The supply air temperature is set manually in steps of 1 K in the main menu display by choosing the temperature symbol.

If an electrical re-heater is installed the temperature setpoints are: 12-22 °C. For installed water re-heater the setpoints are: 12-40 °C.

If the re-heater is deactivated, the temperature steps are: 15-19 °C. Default value: 15.0 °C.

Each temperature step is illustrated by increasing the filling of the temperature symbol and the temperature is shown in the display

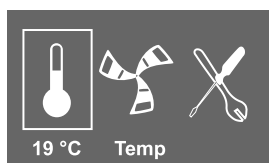

An unfilled temperature symbol will activate manual summer mode. See chapter 9.3

### 9.2 Manual setting of airflow

It is possible, at any time, to manually set the airflow in the main menu display. By choosing the fan symbol and confirming, it is possible to increase or decrease the airflow in 5 steps: Off, Low, Nom, High and Auto.

By doing so, you override the programmed week schedule for the unit until the end of the present time period in the week program (chapter 7.7).

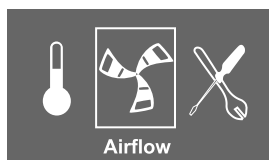

## Warning

It is **not** recommended to activate manual fan stop (set fan to OFF) in standard households. If manual fan stop is activated, the unit should be provided with dampers in exhaust and fresh air ducts to avoid cold draught and risk of condensation when the unit has been stopped.

The fan can be set to OFF by activating manual fan stop. See the Installation and Service manual, chapter Service menu overview: Manual fan stop.

## 9.3 Manual and automatic summer mode

Manual summer mode occurs if no temperature step is selected. The temperature symbol on the main menu is then completely empty.

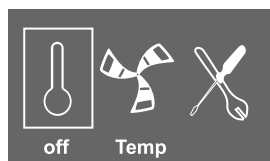

If the electrical re-heater is activated, it will switch off during manual summer mode. Manual summer mode goes automatically to step 1 (setpoint 12 °C) after two minutes if the supply air temperature is +5 °C or below.

If a water heater battery is installed and activated, the manual summer mode goes automatically to step 1 (setpoint 12 °C) if the outdoor air or supply air temperature is +5 °C or below.

The unit will automatically alternate between winter operation with heat recovery and summer operation without heat recovery.

## 9.4 Cool recovery

If the outdoor air is warmer than the extract air and the supply air is above the setpoint, cool recovery occurs. This condition blocks the heat regulation process.

## 9.5 Service menu overview

Enter the service menu by selecting the service symbol in the display.

Menu Level 1	Menu Level 2	Menu Level 3	Explanation
<b>Service</b> Password	<b>Password</b> Password XXXX Locked YES/NO		Enter the service level by typing 1111. Use the SELECTION knob for each digit and confirm with the ENTER button after each set digit. NO will unlock the system and allow parameter changes.
<b>Service</b> Change Password	<b>Change password</b> Actual XXXX New XXXX Confirm XXXX		<b>Set</b> new password if necessary.  In case the new password would be forgotten or misplaced, it's still possible to enter the service level by writing 8642. This overrides the earlier set password.



Menu Level 1	Menu Level 2	Menu Level 3	Explanation
<b>Service</b> Filter period	<b>Filter period</b> Time to replace: 12month  Reset NO/YES		<b>Shows</b> selected time interval between filter change.  <b>Set</b> Reset of the filter period to YES after completed filter change.  <b>Set</b> time between filter changes.
<b>Service</b> Time/Date	<b>Time/Date</b> YY/MM/DD  Date: 12/09/12  Time: 10:00 Weekday: Sat		<b>Shows</b> current set date and time.  <b>Set</b> Correct date and time.
<b>Service</b> Summer/Winter	<b>Summer/Winter</b> Auto time change? YES/NO		Use this dialog frame to configure automatic summertime/wintertime change-over. Time will automatically change between summertime and wintertime according to European standard, based on Greenwich time zone. Default value YES.  <b>Set</b> YES or NO
<b>Service</b> Ext/Force Run	<b>Ext/Force Run</b> Remaining time 5 Minutes: 0  Airflow: Nominal		Use this dialogue frame to program extended time you want the unit to work under operation conditions other than determined by the week schedule.  <b>Shows</b> remaining time of extended/forced running.  <b>Shows</b> set time for extended/forced running.  <b>Shows</b> Set airflow.  <b>Set</b> the time that the unit is to run in extended/forced mode. Value range: 0–240 minutes.  <b>Set</b> the airflow for this mode. Choose between Low, Nom or High. Default value: Nom.
<b>Service</b> Week program	<b>Week program</b> Week program	<b>Week program</b> Day: MON Per 1: 07:00 16:00 Per 2: 00:00 00:00	Program how you want the unit to operate according to the week schedule. It's possible to set 2 periods per day.  <b>Set</b> week day and time interval for the time you want the unit to be in ON mode.

Menu Level 1	Menu Level 2	Menu Level 3	Explanation
	<b>Week program</b>  Airflow	<b>Airflow</b>  On level: low/nom/high/auto Off level: off/low/nom/high	Use this dialogue frame to determine the ON and OFF function for the fans in the week schedule.  <b>Set ON level.</b> Choose between Low, Nom, High or Auto. Default value: Nom  <b>Set OFF level.</b> Choose between OFF, Low, Nom or High. Default value: Low.
<b>Service</b> Airflow log	<b>Airflow log</b>  Level: 1-5 Reset: NO/YES SF: 140 /140 EF: 140 /140		Use this dialogue frame to see how the fans have operated during the time (h) they have been active.  The airflow are shown in 5 different levels: <ul style="list-style-type: none"> <li>• Level 1: 0%</li> <li>• Level 2: 1 – 29%</li> <li>• Level 3: 30 – 44%</li> <li>• Level 4: 45 – 59%</li> <li>• Level 5: 60 – 100%</li> </ul> Choose between the levels to see the time in hours the fans have been active in the different levels.  Reset Yes resets the SF and EF time in the left column for all levels. The right column continues to count ahead and can not be reset.  <hr/> <b>Note:</b>  Factory reset (see Functions ->Factory reset) will not affect this function  <hr/>
<b>Service</b> Functions	<b>Functions</b>  Heater/Cooler	<b>Heater/Cooler</b>  Preheater: YES/NO Reheater: None/Electrical/Wa- ter/Other	Use this dialogue frame to set up the unit for heating and/or cooling.  <b>Set YES</b> to activate preheater. Default setting is NO.

Menu Level 1	Menu Level 2	Menu Level 3	Explanation
		Cooler: None/Water	<hr/> <p><b>Note:</b></p> <p>If preheater is activated and heat exchanger control is set to “On/Off”, it is highly recommended to choose defrost level 0 to avoid conflicts with defrosting functions.</p> <hr/> <p><b>Set</b> Re-heater to None, Electrical, Water or Other.</p> <hr/> <p><b>Note:</b></p> <p>If reheater is set to Other, external heater is only controlled by AO1 (0–10V). Overheat or frost protection is not available.</p> <hr/> <p><b>Set</b> Cooler to None or Water.</p>
	<p><b>Functions</b></p> <p>Temp. Control</p>	<p><b>Temp. control</b></p> <p>P-band: 5°C I-time: OFF Output: 0–100%</p>	<p>Use this dialog frame to adjust the settings of supply air temperature controller.</p> <p><b>Set</b> the proportional band (P-band) range for PI controller. Default value 5°C.</p> <p><b>Set</b> integral time (I-time) range for PI controller. Default value Off.</p> <p><b>Shows</b> output signal presented for the supply air temperature controller.</p>
	<p><b>Functions</b></p> <p>Exchanger Control</p>	<p><b>Exchanger control</b></p> <p>On/Off / Variable</p>	<p>Use this dialog frame to select heat exchanger controller type.</p> <p><b>Set</b> On/Off to active temperature control and defrosting based on defrost levels 0–5.</p> <p><b>Set</b> Variable to activate temperature control and moisture transfer control (if available).</p>

Menu Level 1	Menu Level 2	Menu Level 3	Explanation												
	<b>Functions</b> Preheater	<b>Pre-Heater</b> Preheater Sp: -30 - 0°C) P-band: 5°C Output: Auto (xx%) / Man (Off/On)	Use this dialog frame to configure pre-heater function. Configure the setpoint setting. Default value is dependant on system type. In counter flow units setpoint is not adjustable. <b>Set</b> the proportional band (P-band) range for PI controller. Default value 5°C. <b>Set</b> output to Auto or Man. Default setting is Auto. Actual controller output signal is presented in auto mode. Selecting Man, enables the user to manually control output of the preheater (On/Off).												
	<b>Functions</b> Frost protection	<b>Frost protection</b> Alarm limit: 7°C	<b>Shows</b> current set frost protection alarm limit in °C for the installed water coil. <b>Set</b> Alarm limit in °C. Default value: 7°C.												
	<b>Functions</b> System curve	<b>System curve</b> EF: 1-10 SF: 1-20	This function is to compensate the flow values for different system pressures. See chapter 7.3												
	<b>Functions</b> Fan control	<b>Fan control</b> Airflow System curve %	Select the type of fan control you prefer. Fan control by l/s, m³/h or %												
	<b>Fan control</b> Airflow	<table border="1"> <thead> <tr> <th>Airflow</th> <th>EF</th> <th>SF</th> </tr> </thead> <tbody> <tr> <td>Nom</td> <td>82</td> <td>82</td> </tr> <tr> <td>High</td> <td>100</td> <td>100</td> </tr> <tr> <td>Low</td> <td>49</td> <td>49</td> </tr> </tbody> </table>	Airflow	EF	SF	Nom	82	82	High	100	100	Low	49	49	Use this dialogue frame to set the airflow in l/s. The airflow can be set individually for each fan <b>EF:</b> Extract fan, <b>SF:</b> Supply fan <b>Set</b> the airflow for EF and SF for each step (Low, Nom, and High). System curve shall only be available in case a system with that type of fan control is used.
Airflow	EF	SF													
Nom	82	82													
High	100	100													
Low	49	49													
	<b>Fan control</b> Airflow unit	<b>Airflow unit</b> l/s / m³/h / %	Default value: l/s												

Menu Level 1	Menu Level 2	Menu Level 3	Explanation												
	Demand control	Demand control CO2 / RH Setpoint 0 ppm/0% RH P-Band 100 ppm/10%RH I-Time OFF	<p>It is possible control the indoor air quality using RH (Relative humidity) or CO2 (Carbon dioxide) sensor/sensors. Default setpoint setting is Off. (0%/0ppm).</p> <p>Both types should be able to use at the same time, meaning 2 PI controllers. When demand control setpoint is configured, fans set to auto mode and regulate against the setpoint. The fan symbol should have the middle area empty, and the outer and inner filled. It should not be possible to change either.</p>												
	<b>Fan control</b>  Airflow	<table border="1"> <thead> <tr> <th>Airflow %</th> <th>EF</th> <th>SF</th> </tr> </thead> <tbody> <tr> <td>Nom</td> <td>50</td> <td>50</td> </tr> <tr> <td>High</td> <td>100</td> <td>100</td> </tr> <tr> <td>Low</td> <td>25</td> <td>25</td> </tr> </tbody> </table>	Airflow %	EF	SF	Nom	50	50	High	100	100	Low	25	25	<p>Use this dialogue frame to set the airflow in %. The airflow can be set individually for each fan  <b>EF</b>: Extract fan,  <b>SF</b>: Supply fan</p> <p><b>Set</b> the airflow for EF and SF for each step (Low, Nom, and High).</p>
Airflow %	EF	SF													
Nom	50	50													
High	100	100													
Low	25	25													
	<b>Functions</b>  Manual fan stop	<b>Manual fan stop</b>  Allow manual fan stop Y/N	<p><b>Set</b> if it should be possible to turn off the fans in the unit manually from the control panel.</p> <p>Chose between <b>Y</b> and <b>N</b>.</p> <p>If <b>Y</b> is selected the fans can be turned off by turning the SELECTION knob to empty fan</p>												
	<b>Functions</b>  Analog input	<b>Analog input</b>  1: SS 20.0 2: ETS 23.0 3: Unused/PHS 4: Unused/OT/FPS 20.0 5: OS 10.5 6: RH 0%	<p><b>Shows</b> analogue inputs from active temperature sensors.</p> <p><b>SS</b>: Supply air temp sensor.  <b>ETS</b>: Extract air temp sensor.  <b>PHS</b>: Preheater sensor.  <b>FPS</b>: Frost protection sensor.  <b>OS</b>: Outdoor air temp sensor.  <b>OT</b>: Overheat protection sensor.  <b>RH</b>: Relative humidity sensor.</p>												

Menu Level 1	Menu Level 2	Menu Level 3	Explanation
	<p><b>Functions</b></p> <p>Analog output</p>	<p><b>Analog output</b></p> <p>A01 auto/man/off A02 auto/man/off A03 auto/man/off</p>	<p><b>Shows</b> current analogue outputs in 0–10 V to hot/cold water actuator or electrical re-heater and rotor drive / bypass damper.</p> <p><b>Set</b> AO1 (Analogue output to hot water actuator or electrical re-heater) to auto, man or off. Default value: auto.</p> <p><b>Set</b> AO2 (Analogue output to cold water actuator) to auto, man or off. Default value: auto.</p> <p><b>Set</b> AO3 (Analogue output to rotor drive or bypass damper) to auto or man. Default is auto. Selecting man enables the user to manually control the actuator/damper with a 0–10 V signal. 0 V completely closed and 10 V completely opened actuator/bypass damper.</p>
	<p><b>Functions</b></p> <p>Digital input</p>	<p><b>Digital input</b></p> <p>DI1 ON/OFF DI2 ON/OFF DI3 ON/OFF DI4 ON/OFF DI5 ON/OFF DI6 ON/OFF DI7 ON/OFF</p>	<p><b>Shows</b> current status of the digital inputs ON or OFF</p> <p>DI1: Fan configuration DI2: Fan configuration DI3: Fan configuration DI4: Heater deactivated DI5: Extended/forced running DI6 for rotating heat exchanger: Rotor sensor DI6 for counter flow heat exchanger: Bypass damper limit switch DI7: Home/leave</p>
	<p><b>Functions</b></p> <p>Config DI 1-3</p>	<p><b>Config DI1-3</b> DI:1-3</p> <p>SF: high EF: high Polarity: N.O/N.C Delay: Off-240s</p>	<p>DI 1–3 are free to use for any purpose and have a different priority, DI1 being the highest. DI 1–3 have a higher priority than DI5.</p> <p>It is possible to invert input function.</p> <p><b>Set</b> DI 1–3 to be normally open (N.O) or normally closed (N.C). Default setting N.O.</p> <p>It is also possible to set how you want the fans to react to</p>

Menu Level 1	Menu Level 2	Menu Level 3	Explanation
			<p>3 different digital inputs when they are switched on.</p> <p>Potential free switches need to be connected physically to terminals on the main print card to obtain the different functions. See the wiring diagram for more information.</p> <p><b>Set</b> the supply air fan (SF) and extract air fan (EF) individually to off, low, nom or high for digital inputs 1–3</p> <p><b>Set</b> a predefined off delay for the input signal. System will be in the ON state for predefined period or as long as DI is activated and period is set to 0. Counting down for the predefined period starts when DI function is deactivated. Default value is 0 sec.</p> <p>Actual delay counter is shown and counting when function is activated.</p>
	<p><b>Functions</b></p> <p>DI 4–7</p>	<p><b>DI 4–7</b></p> <p>4 Stop heat 5 Ext run 6 Damper/Rotor 7 Home/Leave</p>	<p>DI 4–7 are default set from factory and can't be changed by the user. Below follows a short description of each function.</p> <p>DI4: Makes it possible to disable the electrical re-heater. Activated input means that the electrical/other re-heater is deactivated.</p> <p>DI5: Activate the Extended/forced running function. The function overrides current set airflow settings and runs according to the settings in <i>Service-&gt;Ext/Force run</i>. Choose between Low, Nom and High for this function. The input is calculated based on the signals from an impulse-switch. If a standard switch is used, the countdown of the set time starts when the switch is switched off.</p> <p>DI6 for rotating heat exchanger: Rotor sensor. Used by the system to monitor the rotor rotation.</p>

Menu Level 1	Menu Level 2	Menu Level 3	Explanation
			<p>DI6 for counter flow heat exchanger: Bypass damper limit switch. Used by the system to detect the damper position.</p> <p>DI7: Activates low energy support control. Heat exchanger operating by the adjusted setpoint value and a active re-heater has support control for the lowest setpoint. (12 °C)</p> <p>The function is used when the building is uninhabited for a longer period.</p> <p>It is recommended to connect DI7 and DI1 or DI3 in parallel. If DI7 is activated, set the fans speed to min. Airflow settings are done when configuring DI1/DI3.</p>
	<p><b>Functions</b></p> <p>Digital output</p>	<p><b>Digital output</b></p> <p>1: SF 67% 2: EF 67% 3: Rot ON/OFF 4: ALARM Y/N 5: Dmp Y/N 6: Heater Y/N</p>	<p><b>Shows</b> The current status of digital outputs 1–6 (the settings in the column to the left are examples).</p> <p>1: SF 67%: Current set speed of the supply air fan (shown as percentage of the maximum speed).</p> <p>2: EF 67% Current set speed of the extract air fan (shown as percentage of the maximum speed).</p> <p>3: Shows if the rotor is active or not. Unused for unit with counter flow heat exchanger.</p> <p>4: Alarm Y/N: Indicates if the sum. alarm is active or not</p> <p>5: Dmp OFF: Outdoor/exhaust air damper is on or off.</p> <p>6: Heater Y/N: Indicates if the electrical re-heater is active or not.</p>



Menu Level 1	Menu Level 2	Menu Level 3	Explanation
	External sensors	External sensors CO2: 0 ppm – RH: 0% –	<p>Last valid value is presented for the bounded sensors.</p> <p>Highest actual sensor signal presented via –/modbus/wireless.</p> <p>Unbound sensor presented as – (none).</p> <p>Modbus sensors has priority over wireless sensors.</p>
	<p><b>Functions</b></p> <p>External DI</p>	<p><b>External DI</b></p> <p>Active Wireless: DI1/..DI20 Assign to: –/DI-5/DI7</p>	<p>External DI menu only available if one or several “Input modules” are bound to the system. Active wireless DI1-20 is depended on actual node for “Input module”.</p> <p>Node shown in “Wireless” menu which node representing DI module inputs.</p> <p>Eg. Node 1 type: DI. Active wireless DI1 and DI2 Node 2 type: DI. Active wireless DI3 and DI4 Node 10 type: DI. Active wireless DI19 and DI20</p> <p>Active wireless DI1-20 are available to assign to DI1-5 and DI7 for the system in the air handling unit.</p> <p>DI6 is not available as selection, used by the system in the air handling unit.</p> <p>Unsigned DI is shown as – (none).</p> <p>To reset a previously assigned DI, select “–” and confirm the selection.</p>
	<p><b>Functions</b></p> <p>Wireless</p>	<p><b>External DI</b></p> <p>Note: 1 Type: None State: No Network Data: 0</p>	<p>Wireless system status.</p> <p>Node: Shows number of bound wireless module.</p> <p>Type: None/UI: User Interface (Control panel)/DI: Digital Input module/CO2: CO2 sensor module/RH: RH sensor module.</p> <p>State: No Network: No gateway connected to the system for air handling unit/Unbound: No bonded module/OK: Successful binding of module</p>

Menu Level 1	Menu Level 2	Menu Level 3	Explanation
			<p>Data: The actual value from module/Comm fail: Communication failure, see manual for actual module for troubleshooting.</p> <p>To reset all bound nodes, see user manual for Gateway Wireless.</p>
	<p><b>Functions</b></p> <p>RH transfer Ctrl</p>	<p><b>RH Transfer Ctrl</b></p> <p>Setpoint: OFF P-band: 20% I-time: OFF</p>	<p>Use this dialog frame to configure intensity of extract air humidity control which helps to avoid moisture transfer to supply air.</p> <p>RH transfer control is enabled if setpoint is higher than 0.</p> <p>Default setpoint value is Off.</p> <hr/> <p><b>Note:</b></p> <p>These settings are only present if heat exchanger controller type is set to Variable.</p> <hr/>
	<p><b>Functions</b></p> <p>Defrosting</p>	<p><b>Defrosting</b></p> <p>Mode 0-5</p>	<p>Use this dialogue frame to set how aggressive you want the defrosting function to operate (see chapter 7.5).</p> <hr/> <p><b>Note:</b></p> <p>These settings are only present if heat exchanger controller type is set to On/Off.</p> <hr/>
	<p><b>Functions</b></p> <p>Calibration</p>	<p><b>Calibration</b></p> <p>Sensor value: 0% Adjusted value: 0% Confirm: YES/NO</p>	<p>Use this dialogue frame to calibrate internal RH sensor for any deviations if necessary.</p> <p>Shows current input signal value of RH sensor.</p> <p><b>Set</b> adjusted value for RH sensor.</p> <p>Adjusted value must be confirmed.</p> <p><b>Set</b> YES to confirm changes.</p>

Menu Level 1	Menu Level 2	Menu Level 3	Explanation
	<b>Functions</b> Modbus	<b>Modbus Settings</b> <b>Settings</b> Address 1 Baud 19200 Parity None	Information about Modbus communication and variables can be found in the Modbus user manual for residential units in the online catalogue at <b>www.systemair.com</b> .
		<b>Modbus Gateway</b> <b>Gateway</b> State Not present/...	<b>Shows</b> current status of communication.
	<b>Functions</b> Factory reset	<b>Factory reset</b> Really reset? YES/NO	Use this dialogue frame to return to factory settings. <b>Set YES or NO</b> <hr/> <b>Note:</b> This will erase all your personal settings that have been done for the unit.
<b>Service</b> Language	<b>Language</b> Language ENGLISH		Use this dialogue frame to return to select your local language. <b>Set Language</b> by turning the SELECTION knob.
<b>Service</b> Versions	<b>Version VSR</b> <b>150/B</b>  CD EC Appl. xxx xxx Boot xxx xxx		<b>Shows</b> current software versions <hr/> <b>Note:</b> The software versions are just an example and may differ in a specific unit.
<b>Service</b> Firmware	<b>Firmware</b>  CD EC Unit xxx xxx Gate- xxx xxx way Update YES /NO		Use this dialogue frame to update firmware. <b>Set YES or NO.</b> <b>Shows</b> current version of the unit and Z-wave Gateway.
<b>Service</b> Alarms	<b>Alarms</b> Fan Frost Bypass Rot Pb Fail Temp Filter Low SS Defrost RH		<b>Shows</b> the alarms that have been triggered. See alarm list (chapter 10.5)

# 10 Service

## 10.1 Warnings

### Danger

- Make sure that the mains supply to the unit is disconnected before performing any maintenance or electrical work!
- All electrical connections and maintenance work must be carried out by an authorized installer and in accordance with local rules and regulations.

### Warning

- The system should operate continuously, and only be stopped for maintenance/service
- Although the mains supply to the unit has been disconnected there is still risk for injury due to rotating parts that have not come to a complete standstill
- Beware of sharp edges during maintenance. Use protective gloves
- Make sure that filters are mounted in their place before running the system
- This product must only be operated by a person which has suitable knowledge or education within this field or carried out with the supervision of a suitably qualified person.

## 10.2 Internal components

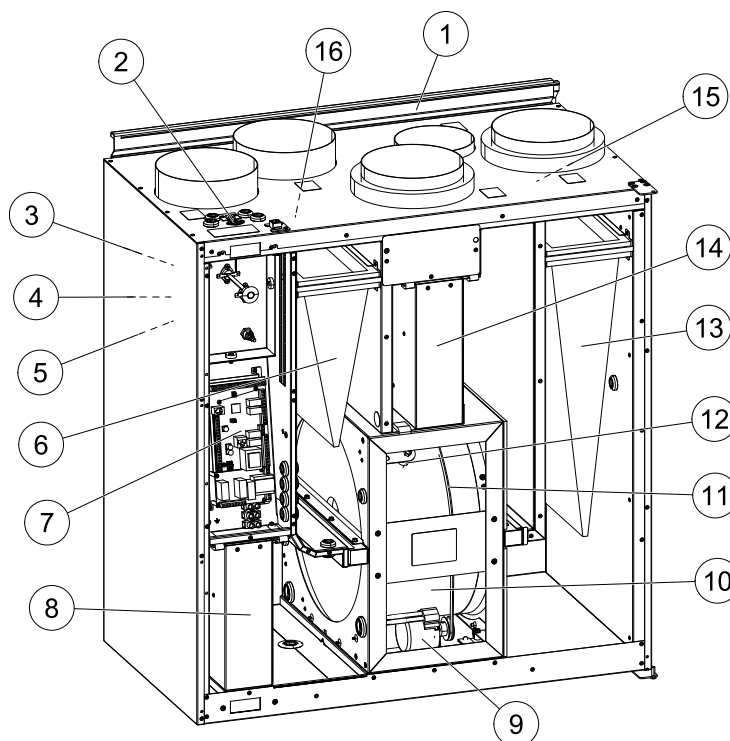

**Fig. 11 Internal components**

Position	Description
1	Mounting bracket

2	External connections
3	Extract air sensor
4	Overheat protection sensor
5	Internal electrical re-heater
6	Extract air filter
7	Main print card
8	Supply air fan
9	Rotor motor and belt pulley
10	Rotating heat exchanger
11	Heat exchanger drive belt
12	Rotor sensor
13	Supply air filter
14	Extract air fan
15	Outdoor air sensor
16	Supply air sensor

## 10.3 Component descriptions

### 10.3.1 Fans

The fans have external rotor motors of EC type which can be steplessly controlled individually 20–100%. The motor bearings are life time lubricated and maintenance free. It is possible to remove the fans for cleaning, see “User Manual” for more information.

### 10.3.2 Filters

The factory installed filters are of filter quality F7 for the supply air and G3 for the extract air filter. The filters need to be replaced when polluted. New sets of filters can be acquired from your installer or wholesaler.

Filter quality G3 can be installed for supply air filtering.  
The filter type is labelled on the top of the filter

---

#### Note:

If type G3 filters are used instead of F7 , the system curve for Supply Fan (SF) must be changed:

For G3 type filter: 11–20, for F7 type filter: 1–10. See chapter 7.3.

---

### 10.3.3 Heat exchanger

SAVE VTR 300/B is equipped with a rotating heat exchanger. Required supply air temperature is therefore normally maintained without adding additional heat.

The heat exchanger is removable for cleaning and maintenance, see “User Manual” for more information.

### 10.3.4 Print card

The main print card controls the functions and set temperatures of the unit.

It is possible to connect external accessories to terminals on the print card and also communication to BMS (Building Management System) Modbus communication via RS-485. See wiring diagram for more information.

### 10.3.5 Temperature sensors

Four temperature sensors (NTC, 10 k $\Omega$  at 25°C) are included in the unit from factory and positioned in the corresponding air chambers.

The sensors are connected to the main print card. See wiring diagram for more information.

### 10.3.6 Humidity sensor

Relative humidity sensor (RHS) is included in the unit from factory and positioned in the extract air chamber.

The sensor is connected to the main print card. See wiring diagram for more information.

### 10.3.7 Electrical Re-heater battery

The re-heater battery is positioned in the supply air chamber.

The re-heater is activated by a relay and switches on if the supply air temperature is lower than the set point and switches off if one or more of the following conditions are met:

1. If the supply air temperature is above the set point.
2. If the over heat protection is activated or the sensor is malfunctioning.
3. If the emergency thermostat is triggered or broken.
4. If the supply air sensor is in error state.
5. If the supply air fan is not running.
6. If the heater is set to disabled in the menu.
7. If re-heater is disabled by digital input 4 (DI 4).

### 10.3.8 Overheat protection reset button

If the supply air temperature is low, it can indicate that the over heat protection is triggered. The overheat protection can be reset by pressing the reset button (1).

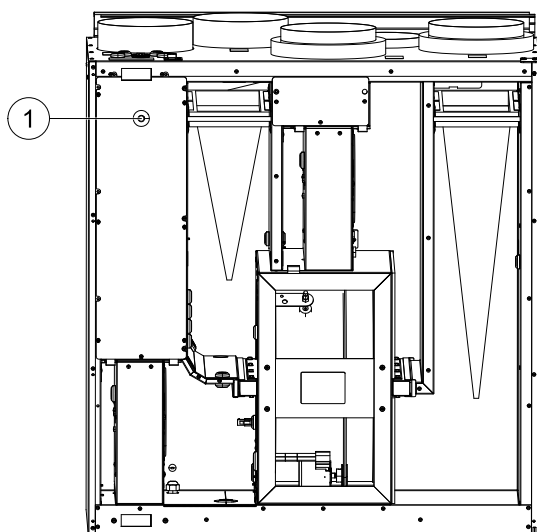

**Fig. 12 Overheat protection reset button**

## 10.3.9 Water re-heater battery

A water re-heater battery (optional), which can be acquired as an accessory, can be controlled by the analog output WH (0-10 V DC). The water heater uses AI 4 for frost protection.

The frost protection sensor should then be a strap on surface sensor situated on the return water tube. Sensor type: TG-A130

The supply air sensor (SS) at AI 1 must be replaced with a duct sensor which can be acquired as an accessory. Sensor type: TG-K360. See wiring diagram for more information.

Only electrical or water re-heater is allowed, i.e. if a water re-heater is selected, the electrical re-heater is deactivated and vice versa.

---

### Note:

If a water re-heater battery is installed we strongly recommend you to also install an outdoor air damper with a spring return actuator.

---

## 10.3.10 Water cooler

A water cooler (optional) can be acquired as an accessory and be controlled by the unit. If a water cooler is installed the supply air sensor (SS) at AI 1 must be replaced with a duct sensor which can be acquired as an accessory. Sensor type: TG-K360. See wiring diagram for more information.

## 10.4 Trouble shooting

A warning triangle with text in the display indicates an alarm. Turn menu selector to the warning triangle and press confirm twice to view the alarm.

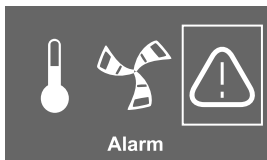

If problems should occur, please check the items below before calling your service representative.

Malfunction	Action
Fans do not start	<ol style="list-style-type: none"> <li>1. Check the display for alarms.</li> <li>2. Check fuse for main power supply in the distribution box for the building and all the quick connectors are connected in the unit (quick connectors for supply and extract air fans).</li> <li>3. Check that the week program is in ON mode. The week program might be in OFF mode with the airflow set to OFF (chapter 7.7)</li> <li>4. Check if one of the digital inputs 1–3 (DI 1–3) is active and set to off. This would force one or both fans to stop depending on the setup (chapter 9.5).</li> </ol>

Reduced airflow	<ol style="list-style-type: none"> <li>1. Check the display for alarms.</li> <li>2. Check setting of airflow in the control panel (chapter 7.1.1).</li> <li>3. Check week program (chapter 7.7).</li> <li>4. Check if one of the digital inputs 1–3 (DI 1–3) is active and set to off. This would force one or both fans to stop depending on the setup (chapter 9.5).</li> <li>5. Check if auto mode is active. Auto mode reduces the airflow if actual value from external sensor/sensors is lower than demand control set-point.</li> <li>6. Check filters. Change of filters required?</li> <li>7. Check diffuser/louver openings. Cleaning of diffusers/louvres required?</li> <li>8. Check fans and heat exchange block. Cleaning required?</li> <li>9. Check if the buildings air intake and roof unit (exhaust) have been clogged.</li> <li>10. Check visible duct runs for damage and/or build up of dust/pollution.</li> </ol>
The unit cannot be controlled (control functions are stuck)	<ol style="list-style-type: none"> <li>1. Reset control functions by pulling out the main power supply plug for 10 seconds.</li> <li>2. Check the modular contact connection between the control panel and the main print card.</li> </ol>
Low supply air temperature	<ol style="list-style-type: none"> <li>1. Check the display for alarms.</li> <li>2. Check set supply air temperature in the control panel.</li> <li>3. Check the analogue inputs in the service menu to verify that the temp sensors are ok (chapter 9.5). Go to <code>Functions &gt; Analogue input</code> and verify the temperature readings from the temp sensors.</li> <li>4. Check that Home/Leave function is disabled DI 7.</li> <li>5. Check if the over heat protection is triggered: <ul style="list-style-type: none"> <li>• For units with built-in heater: If necessary, reset by pressing the red reset button.</li> <li>• For units with external heater: For reset, see the manual for the external electrical heater.</li> </ul> </li> <li>6. Check if digital input 4 (DI 4) is set to off. This would force the electrical re-heater battery to be switched off (chapter 9.5)</li> <li>7. Check if the extract filter must be changed.</li> <li>8. At very cold outdoor conditions an electrical pre heating battery might be necessary. This can be acquired as an accessory.</li> <li>9. Check the balance between the supply and extract air</li> </ol>
Noise/vibrations	<ol style="list-style-type: none"> <li>1. Clean fan impellers.</li> <li>2. Check that the screws holding the fans are tightened.</li> <li>3. Check that the anti vibration pads are fitted at the bottom of the unit.</li> </ol>

## 10.5 Alarm list

Alarm	Explanation	Do the following
Fan	Indicates error on either supply or extract air fan.	<p>The alarm is displayed in the control panel.</p> <p>Check that quick connectors are connected for the both fans.</p>



Alarm	Explanation	Do the following
		Contact your installation company or place of purchase.
EMT/Frost	Indicates triggered frost protection (in case of installed water heating battery) or triggered overheat protection (in case of installed electric re-heater battery).	<p>A triggered frost protection alarm results in the following:</p> <ul style="list-style-type: none"> <li>• Both fans stop.</li> <li>• Outdoor and exhaust air dampers closed.</li> <li>• Water valve opens completely (10 V signal goes out to the actuator).</li> </ul> <p>The unit will restart once the water temperature reaches +5°C above the set frost protection temperature.</p> <p>A triggered over heat protection (EMT) gives an alarm in the control panel.</p> <p>Reset by pushing the reset button. See chapter 10.3.8.</p> <p>If the problem continues contact your installation company or place of purchase.</p>
Rot	Indicates a rotor malfunction.	<p>The alarm is displayed in the control panel.</p> <ul style="list-style-type: none"> <li>• If the rotating heat exchanger has stopped. Check the rotor belt. See chapter 10.6</li> <li>• If the heat exchanger is still rotating, check that the quick connector for the sensor is connected and that there is an air gap of 5-10mm between the sensor and the magnet.</li> </ul> <p>Adjust the gap if necessary.</p> <p>If the alarm persists, the rotor sensor may be faulty.</p> <p>Contact your installation company or place of purchase.</p>
Pb Fail	<p>Error in connection with relay card for the electrical re-heater (if installed and activated).</p> <p>The overheat protection sensor, automatic reset (ET2) may be triggered due to high temperature.</p>	<p>The alarm is displayed in the control panel.</p> <p>The heater will not be activated.</p> <p>For triggered ET2, wait 10–15 min. If the error remains, contact your installation company or place of purchase.</p>
Temp	Malfunction in one or more of the temperature sensors.	<p>The alarm is displayed in the control panel.</p> <p>Contact your installation company or place of purchase.</p>
Filter	Time for filter change.	<p>The alarm is displayed in the control panel.</p> <p>Change filter according to the instructions in the User Manual.</p>
Low SS	Indicates low supply air temperature	<p>The alarm is displayed in the control panel.</p> <p>If water reheater is configured and frost protection have failed, then an extra security function is triggered when supply air temperature is lower than 5 °C and outdoor air temperature is below 0 °C.</p>
RH	Indicates malfunction of internal relative humidity sensor.	The alarm is displayed in the control panel.

## 10.6 Replacing rotor drive belt

### Note:

Depending on model, left or right, it may be necessary to remove the heat exchanger in order to replace a broken drive belt since the belt pulley cannot be accessed.

If the rotor motor is placed at the back of the unit, it is recommended to remove the heat exchanger to change the drive belt, see chapter 10.6.2.

If the alarm `ROTOR` is raised, see chapter 10.5, the rotor drive belt may be damaged or broken.

The replacement drive belt (1) is adjustable and delivered with a nipple attached in one end.

### **Danger**

- Make sure that the Mains supply to the unit is disconnected before performing any maintenance or electrical work!

### **Warning**

Risk of personal injury! The heat exchanger weighs about 14 kg. There is a risk that the heat exchanger falls out of the unit.

Make sure that small children are not beneath the unit when the heat exchanger is removed!

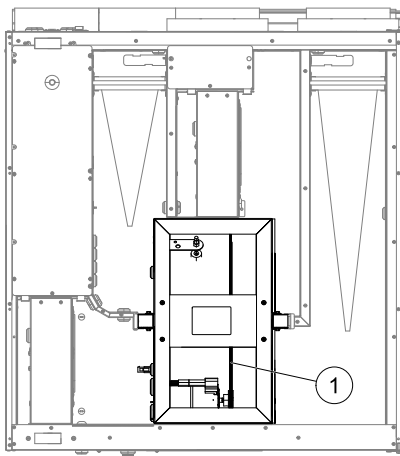

**Fig. 13 Rotor drive belt**

### 10.6.1 Heat exchanger mounted

1. Stop the unit by disconnecting the mains.
2. Open the front hatch.
3. Remove the broken drive belt.
4. Use tape to attach the drive belt to the rotating heat exchanger, and rotate the exchanger by hand to get hold of the drive belt.
5. Remove the tape and put the "empty" end on to the nipple.
6. Press the drive-belt ends firmly towards each other to secure the nipple.
7. Pull the drive belt on to the belt pulley and rotate the exchanger by hand. Check that the belt pulley rotates.

---

**Note:**

If the drive belt slips, the drive belt may be too long and needs to be shortened. Cut the drive belt 5 mm and go to step 6.

---

8. Close and lock the front hatch and connect the unit to mains.
9. Check that the alarm has ceased on the Control Display.

---

**Note:**

If the alarm remains, check the rotor sensor.

---

## 10.6.2 Heat exchanger removed

1. Stop the unit by disconnecting the mains.
2. Open the front hatch.
3. Disconnect the heat exchanger power supply and the rotor sensor. The cables are found beside the heat exchanger at the back.
4. Pull out the heat exchanger towards you. Some force may be needed.
5. Remove the broken drive belt.
6. Apply the new drive belt around the heat exchanger.
7. Press the drive-belt ends firmly towards each other to secure the nipple.
8. Pull the drive belt on to the belt pulley and rotate the exchanger by hand. Check that the belt pulley rotates.

---

**Note:**

If the drive belt slips, the drive belt may be too long and needs to be shortened. Cut the drive belt 5 mm and go to step 7.

---

9. Mount the heat exchanger. Don't forget to reconnect the rotor power and sensor cables.
10. Close the front hatch and connect the unit to mains.
11. Check that the alarm has ceased on the Control Display.

---

**Note:**

If the alarm remains, check the rotor sensor.

---

Systemair Sverige AB reserves the right to make changes and improvements to the contents of this manual without prior notice.



Systemair UAB  
Linų st. 101  
LT-20174 Ukmergė, LITHUANIA  
Phone +370 340 60165  
Fax +370 340 60166  
[www.systemair.com](http://www.systemair.com)